



SGARIA.

Trustable for life



Valves



COMPANY PROFILE



The Sgaria

In addition to the best products, we work objectively and efficiently, with integrity and a sense of urgency to generate the best services.

Check out some of the pillars of our company:

Customer Focus: Our customers are the reason for our existence. We are committed to meeting your demands on site and time required;

Safety: We are strict in meeting our standards, valuing the safety of our customers and contributors;

Quality Results: We seek to maximize results by valuing quality in every detail of our operation;

Teamwork: Together we achieve our goals, acting in a shared way will more easily achieve achievements and good results, sharing achievements and results.

Certificates

By bringing together technical force with design and experience, Sgaria has all the documentation necessary to deliver a certified quality product.





Sgaria Hong Kong

Address:

10 / F, Pilkem Commercial Center, 8
Pilkem Street, Jordan, Kowloon, Hong Kong
VAT CODE: 2288999



Sgaria EUA

Address:

175 SW 7th Street - Unit#1515
Miami - FL 33130
Phone: +1 786 773 4767
VAT CODE: 83-1661307



Sgaria China

Address:

Business Center in Mirae Asset Tower, 166
LujiAzui Ring Road 20Floor
Phone: +852 (3) 6789958
VAT CODE: 91310115MA1K4CN75C



Sgaria Brasil

Address:

VIÓRIA- ES
e-mail: comercial.ind@sgaria.com
Telefone: +55 27 2142-5884
CNPJ: 28.446.398/0001-03





Gas Ball Valve Series
燃气球阀系列



Heating Ball Valve Series
供暖球阀系列



Hard Seal Ball Valve Series
硬密封球阀系列



Special Ball Valve Series
特殊球阀系列(专利产品)



Ball Valve Series
球阀系列



Power Station Valve Series
电站阀系列



Butterfly Valve Series
蝶阀系列



Gate Valve Series
闸阀系列



Globe Valve Series
截止阀系列



Check Valve Series
止回阀系列



Control Valve Series
调节阀系列



Hydraulic Control Valve Series
水力控制阀系列



Special Valve Series
特种阀门系列



Safety Valve Series
安全阀系列



0.5 Seconds Quickly Closed Steam Turbine
With Extraction Check Valve Series
0.5秒快速关闭汽轮机用抽汽止回阀系列



Knife Gate Valve Series
刀型闸阀系列



Bellows Valve Series
波纹管阀门系列



Anticorrosive Valve Series
防腐阀门系列



Oilfield Valve Series
油田阀门系列



Stainless Steel Valve Series
不锈钢阀门系列



Forged Steel Valve Series
锻钢阀门系列



Integrated Product Series
综合产品系列



Electric Actuators Series
电动执行器系列

Quality Assurance Commitment
质量保证



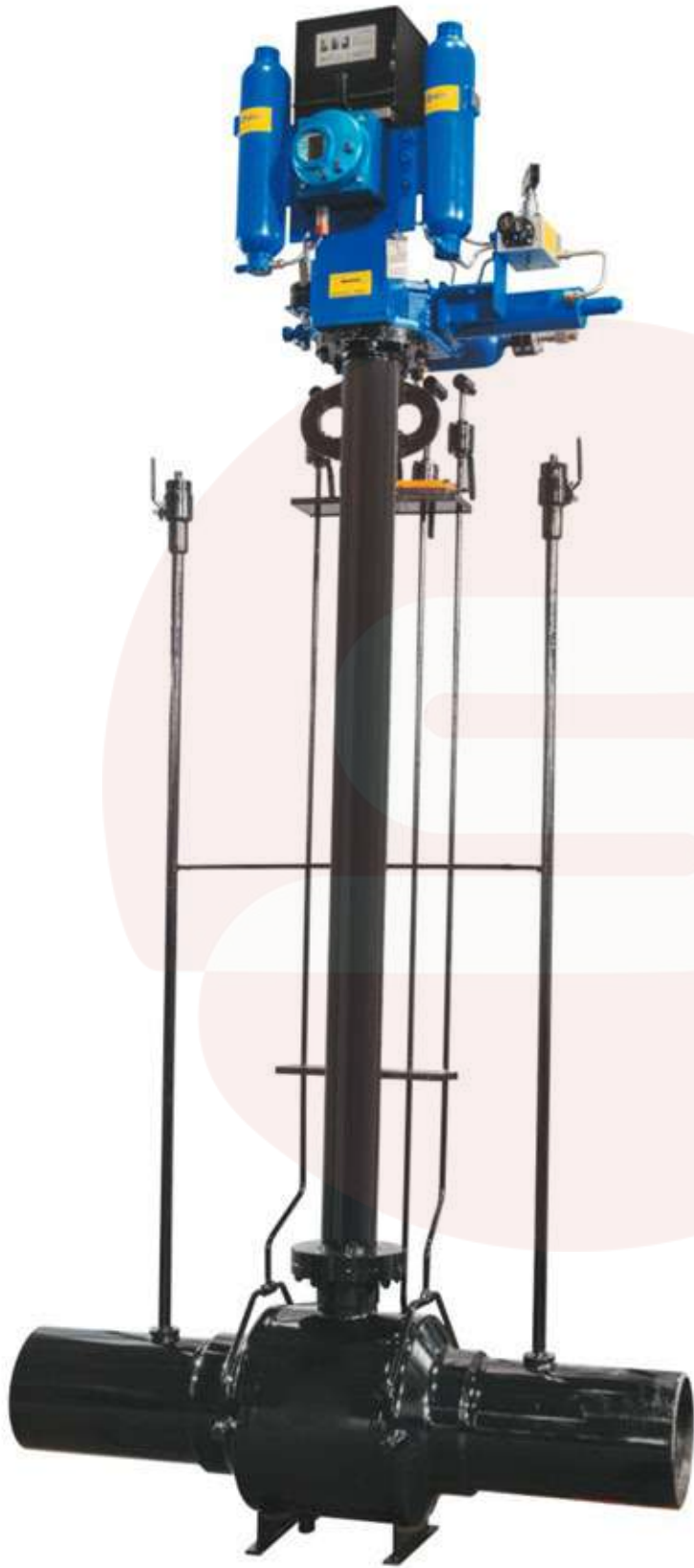







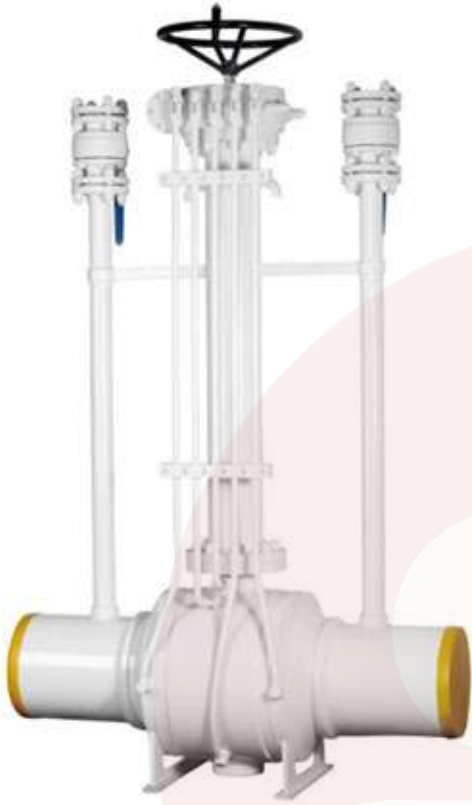





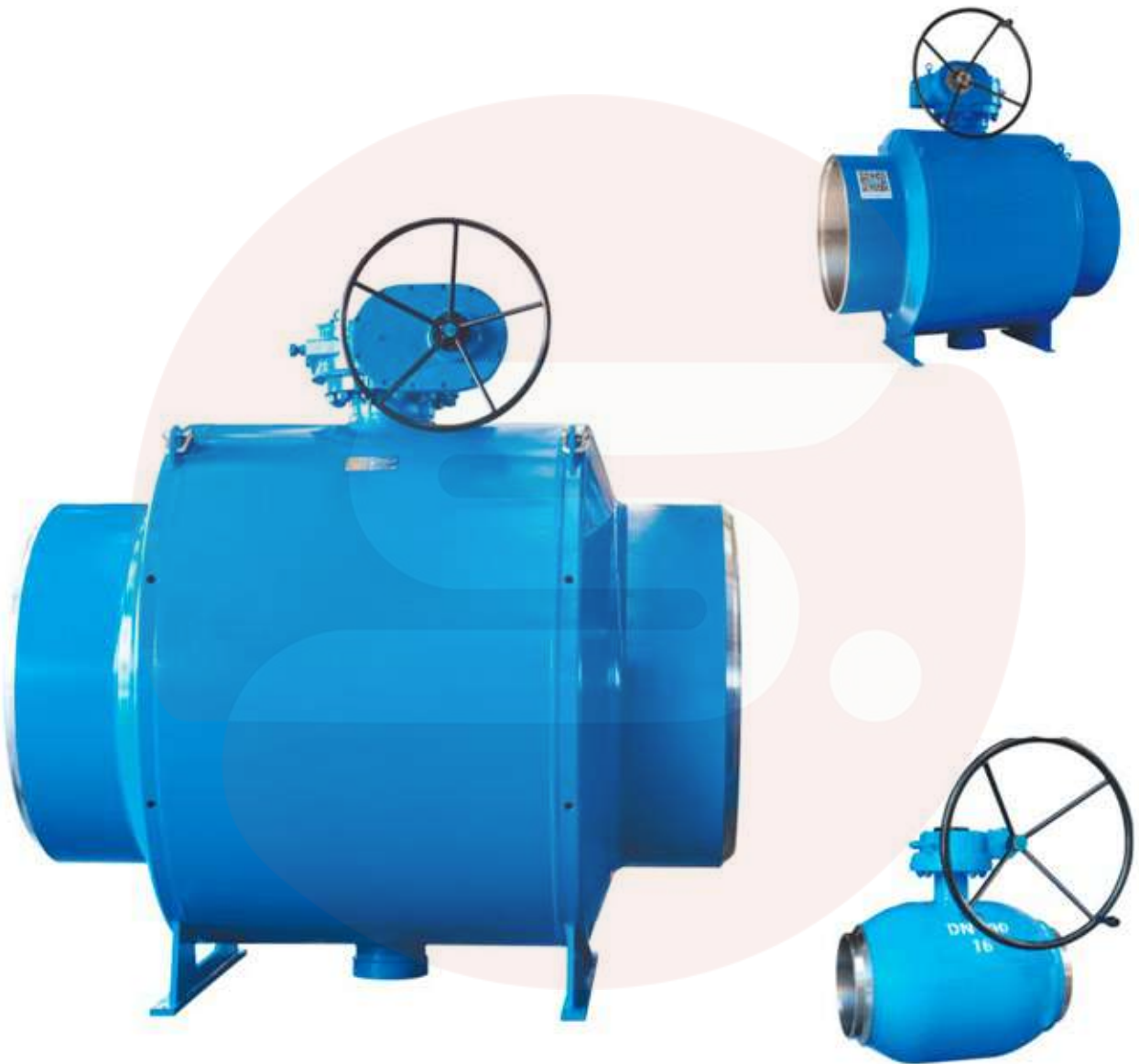



















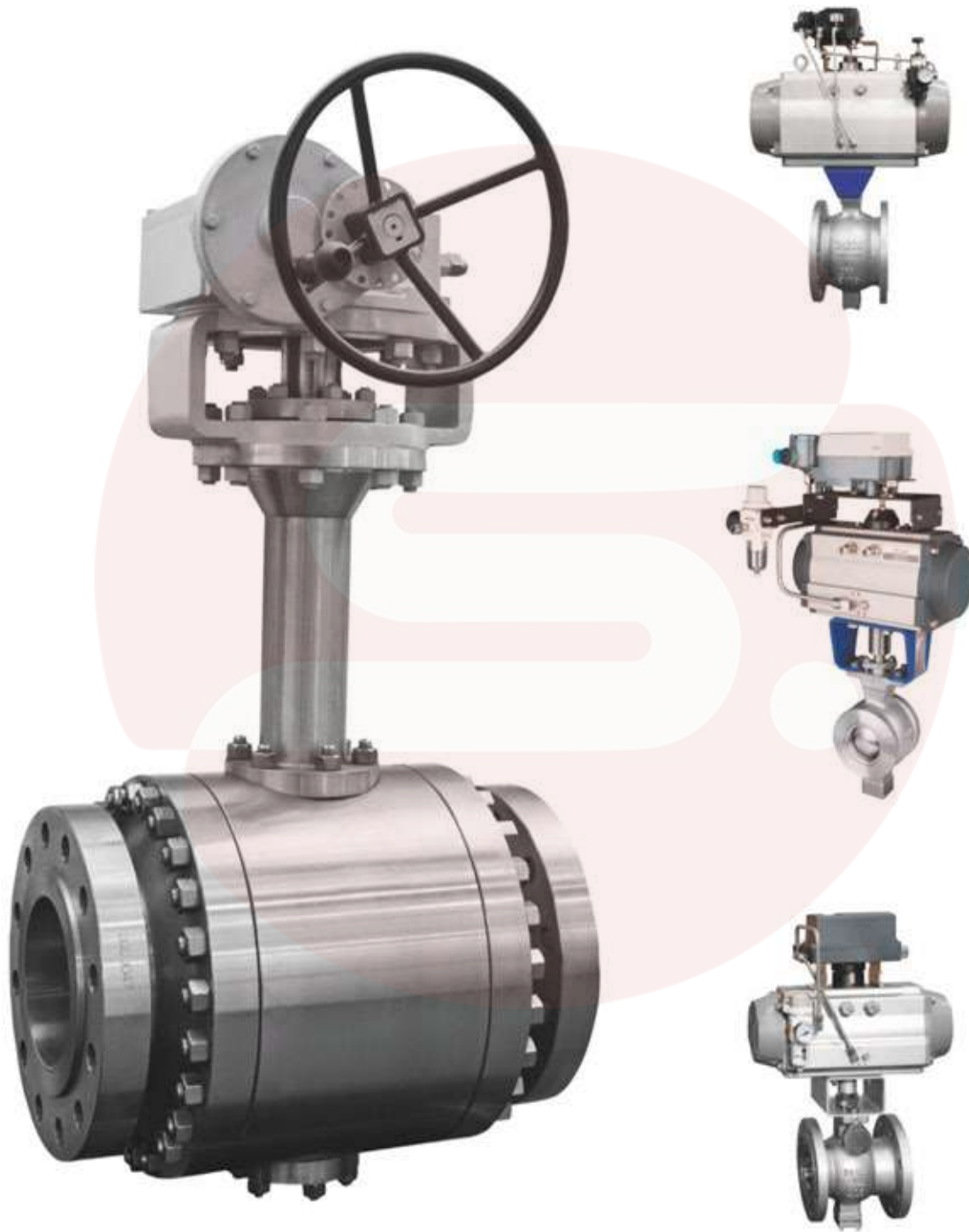













Butterfly Valve Series









Butterfly Valve Series

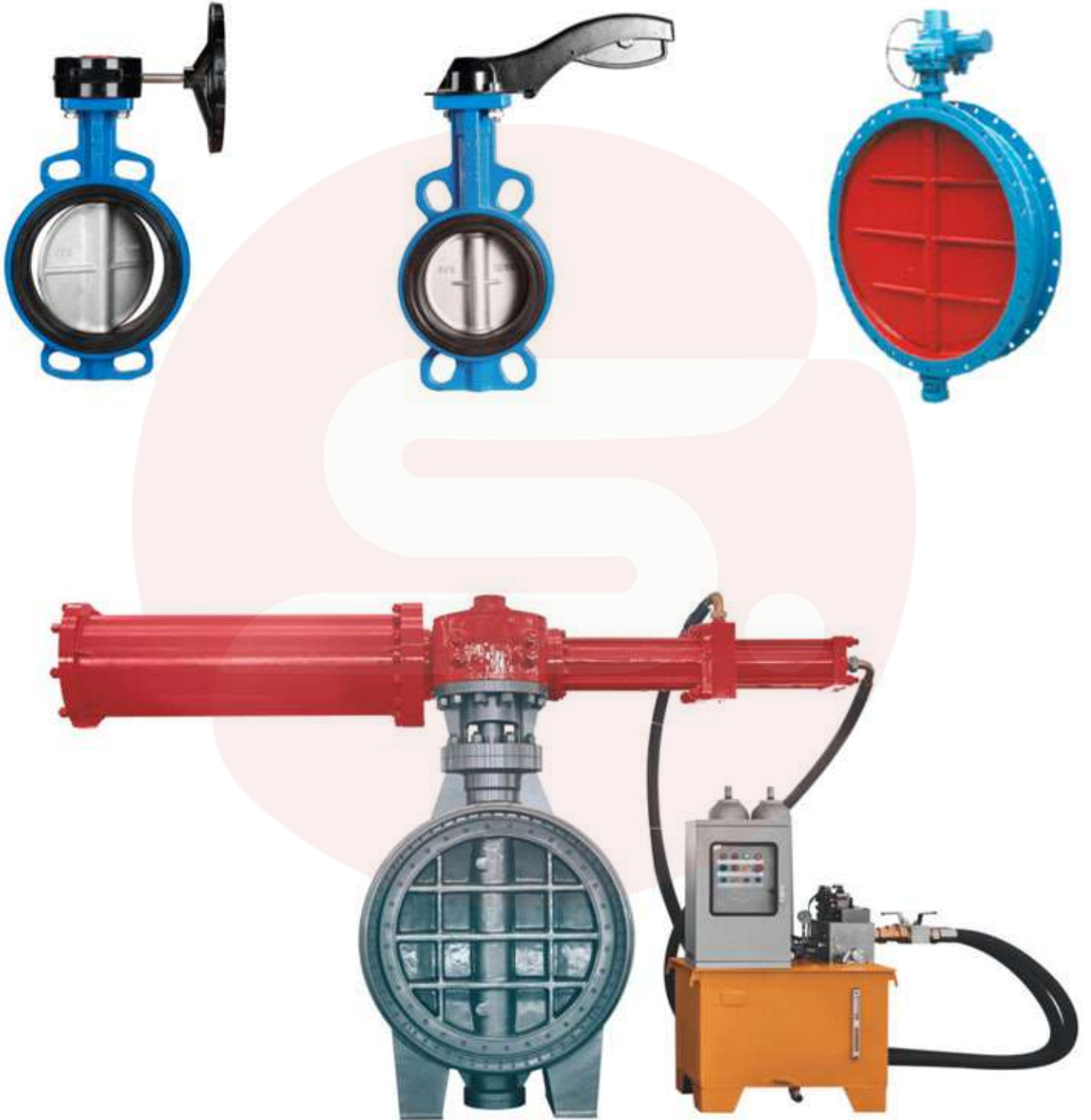







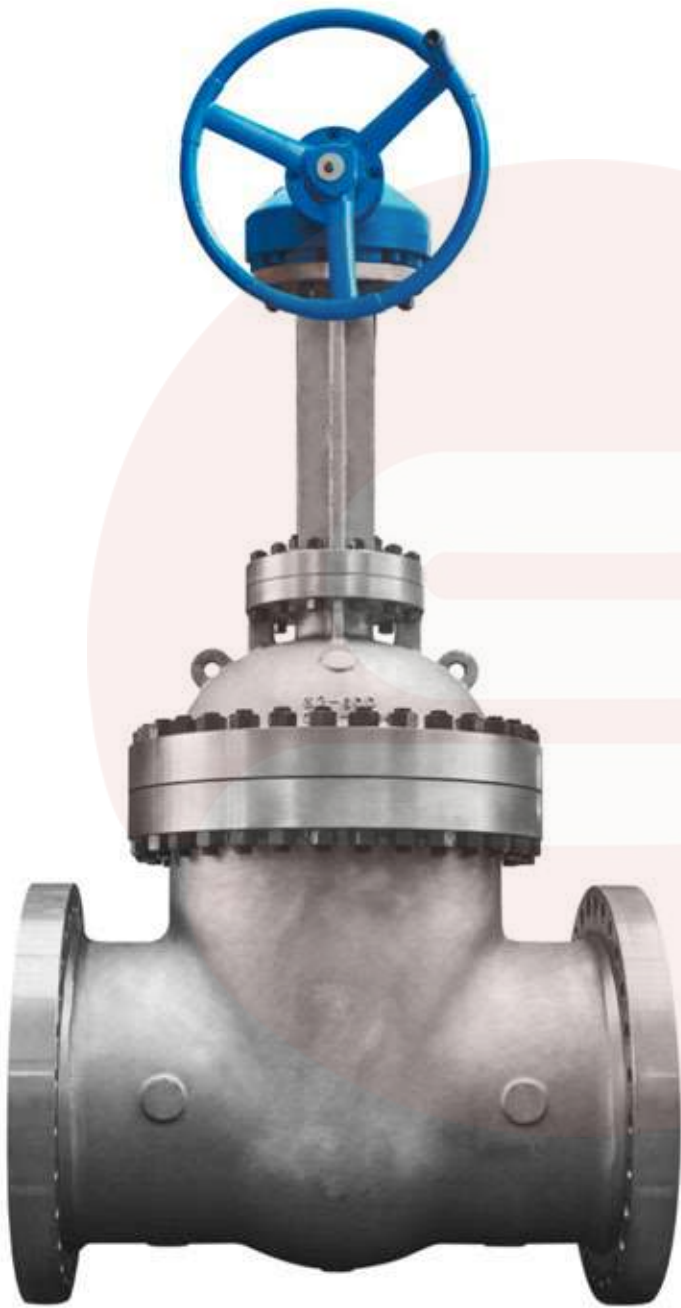















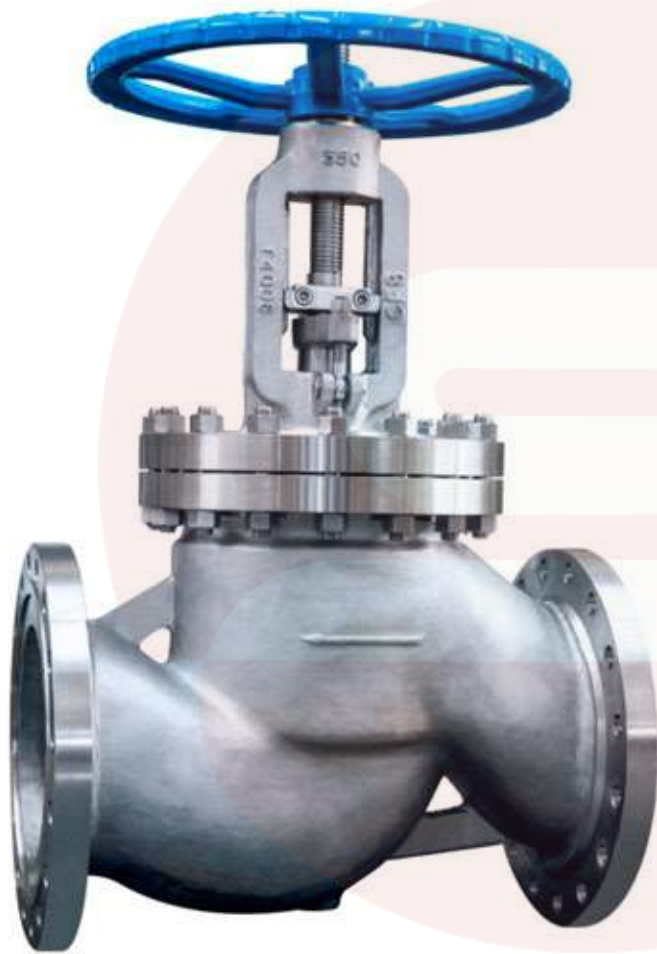

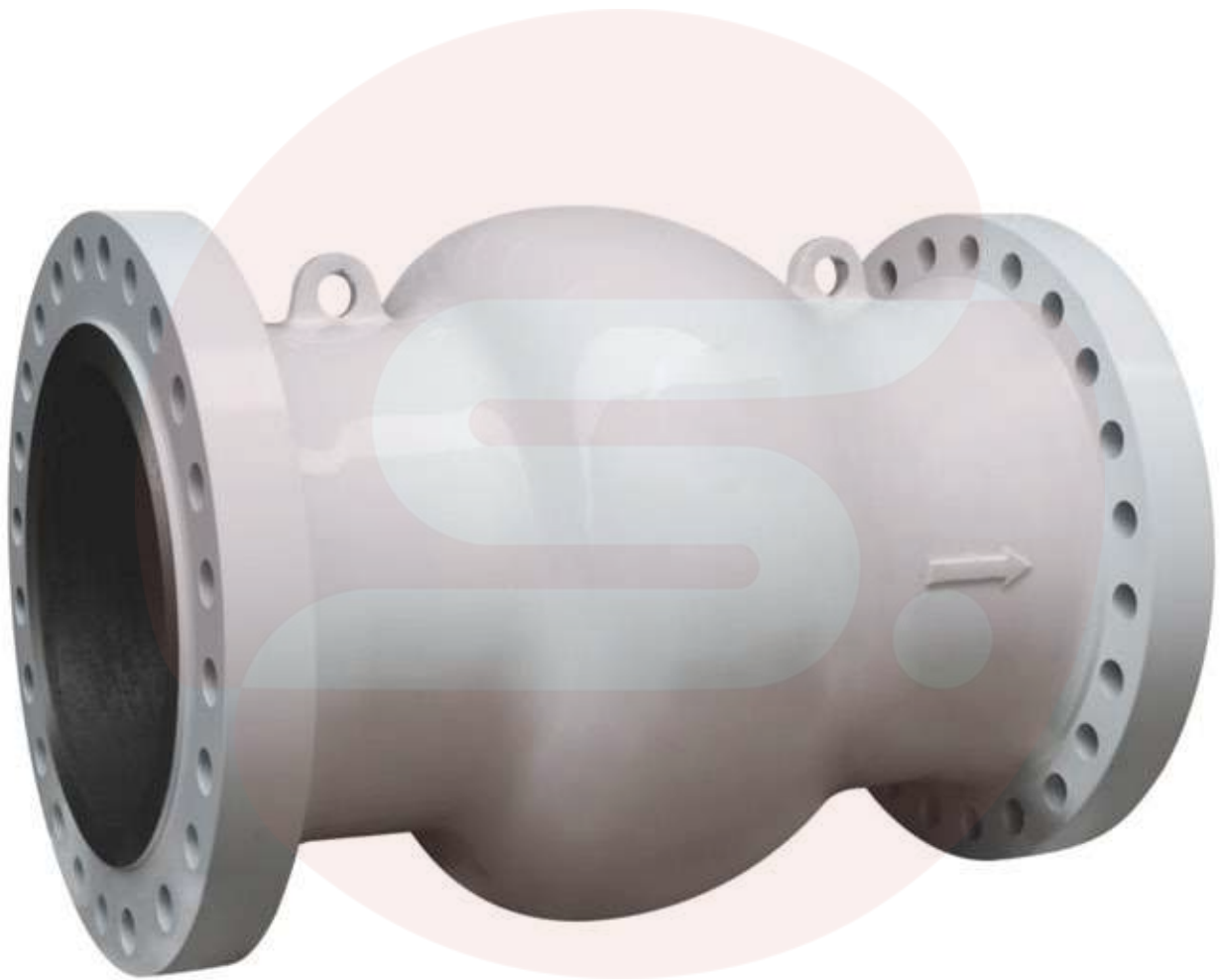

Check Valve Series



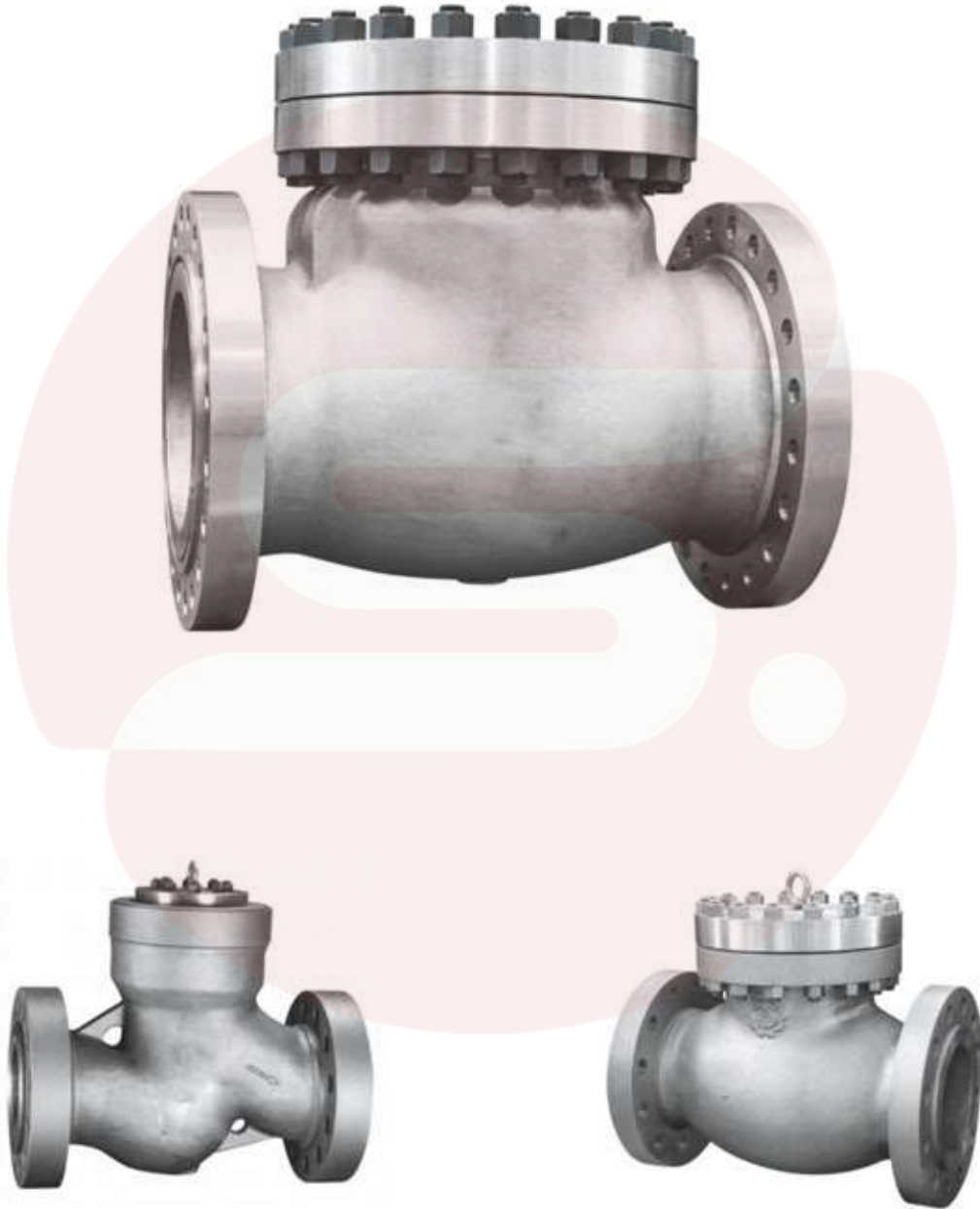















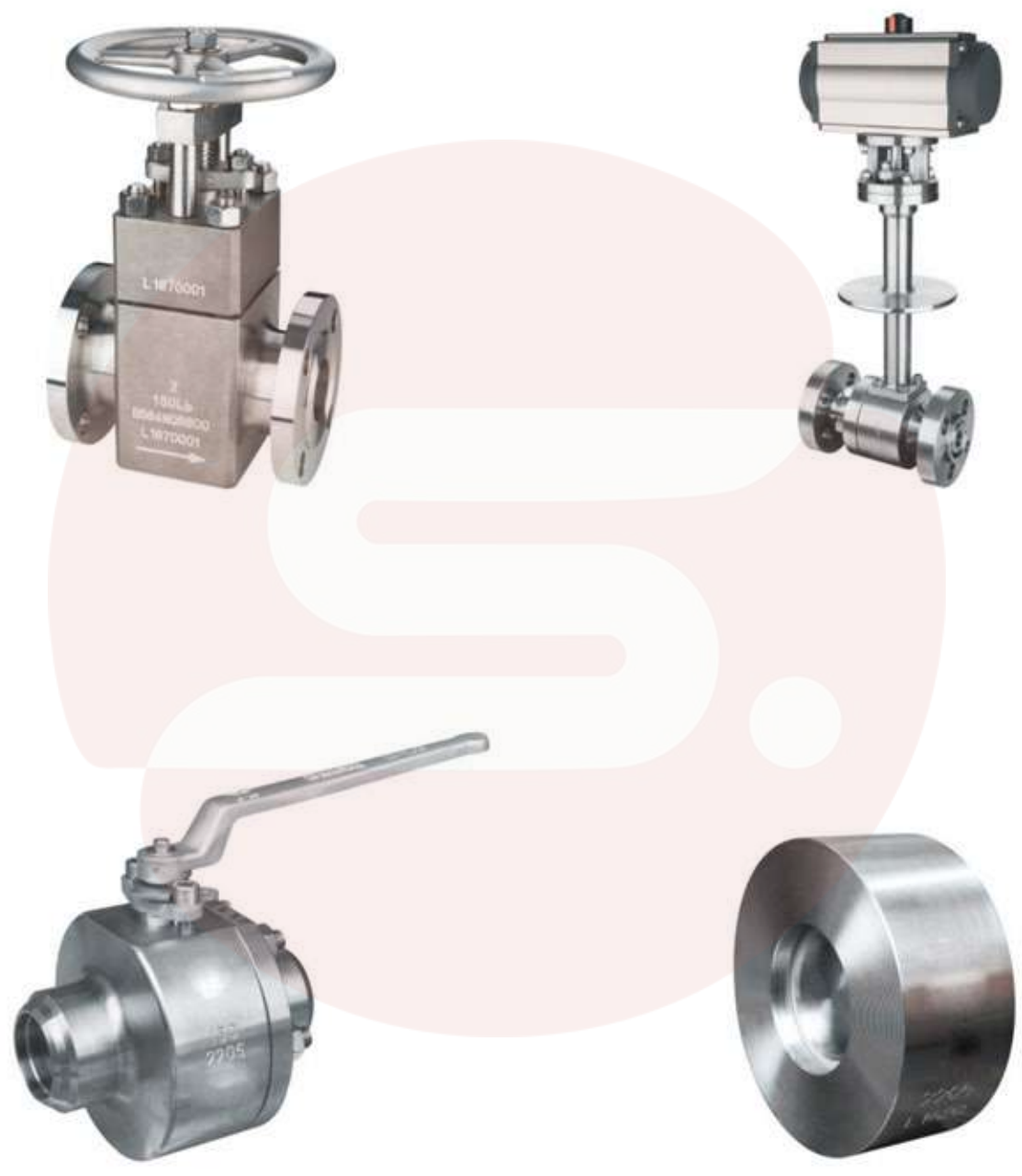







0.5 Seconds Quickly Closed Steam Turbine With Extraction Check Valve Series

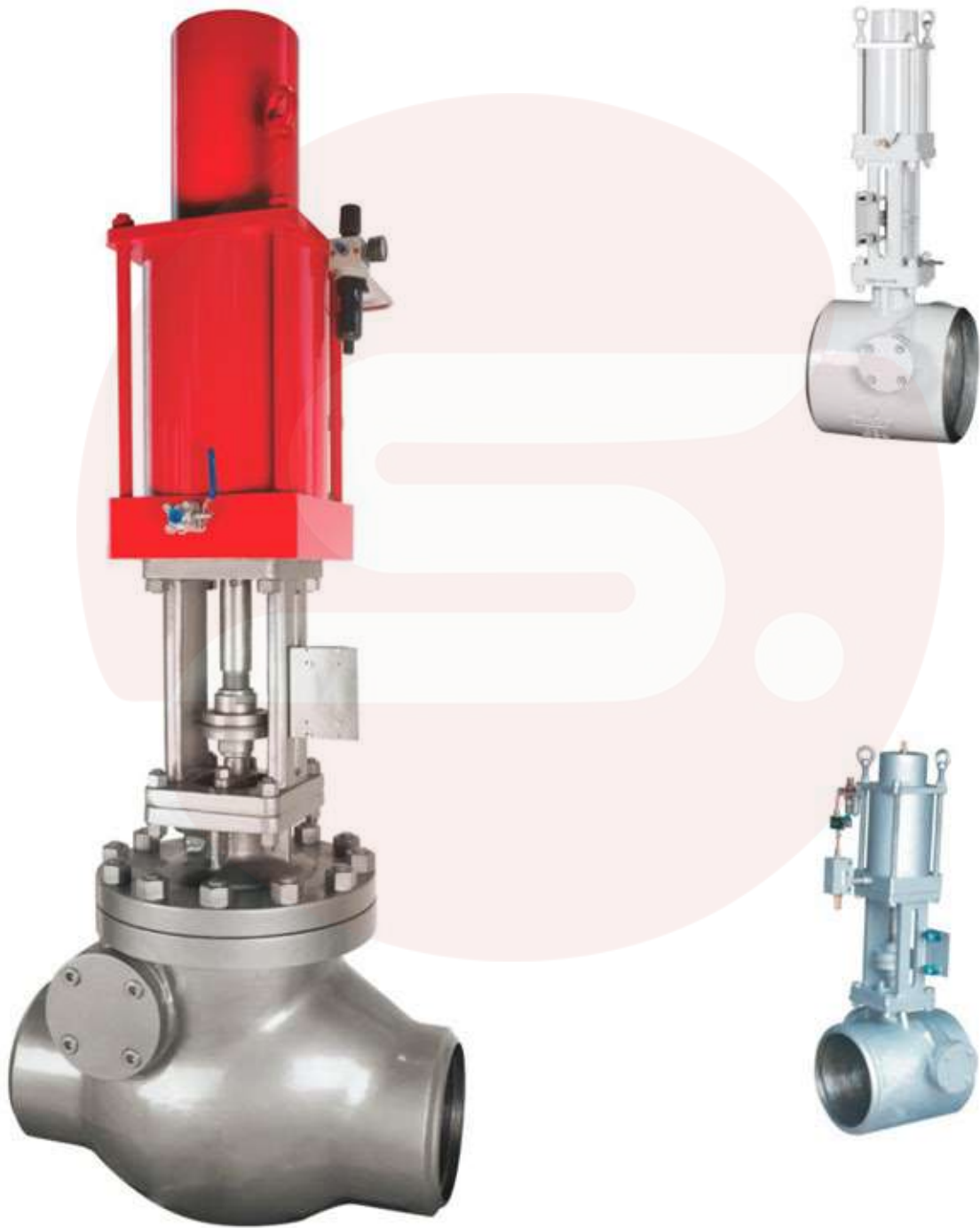

























Forged Steel valve Series













SGARIA.

Trustable for life

[/SGARIAGROUP](#)

